

# one-piece 3.0 & overdenture implant systems











**BIOHORIZONS**<sup>®</sup>  
SCIENCE • INNOVATION • SERVICE

Product Support Specialist: \_\_\_\_\_

Cell phone: \_\_\_\_\_

Fax: \_\_\_\_\_

## Icon Legend

 LOT	Lot/batch number		Single use only
 REF	Reference/article number		Refer to Instructions for Use
 STERILE	Sterile by gamma irradiation		Use before expiration date (YYYY-MM)
 NON-STERILE	Non-sterile		Manufacture date (YYYY-MM)
Rx Only	Caution: Federal (USA) law restricts these devices by, or on the order of, a dentist or physician.		BioHorizons products carry the CE mark and fulfill the requirements of the Medical Devices Directive 93/42/EEC

## Warranty Information

**BioHorizons No Exceptions Lifetime Warranty on Implants and Prosthetics:** All implants and prosthetic components include a No Exceptions Lifetime Warranty. Implant or prosthetic components will be replaced if removal of that product is due to failure (excluding normal wear to overdenture attachments).

**Additional Warranties:** BioHorizons warranties instruments, surgical drills, taps, torque wrenches and Virtual Implant Placement (VIP) treatment planning software.

**(1) Surgical Drills and Taps:** Surgical drills and taps include a warranty period of ninety (90) days from the date of initial invoice. Surgical instruments should be replaced when they become worn, dull, corroded or in any way compromised. Surgical drills should be replaced after 12 to 20 osteotomies.<sup>1</sup>

**(2) Instruments:** The BioHorizons manufactured instrument warranty extends for a period of one (1) year from the date of initial invoice. Instruments include drivers, sinus lift components, implant site dilators and BioHorizons tools used in the placement or restoration of BioHorizons implants.

**(3) VIP treatment planning software:** VIP treatment planning software warranty extends for a period of ninety (90) days from the date of initial invoice. The warranty requires that VIP be used according to the minimum system requirements.

**(4) Compu-Guide surgical templates:** Compu-Guide surgical templates are distributed without making any modifications to the submitted Compu-Guide Prescription Form and VIP treatment plan ("as is"). BioHorizons does not make any warranties expressed or implied as it relates to surgical templates.

**Return Policy:** Product returns require a Return Authorization Form, which can be acquired by contacting Customer Care. The completed Return Authorization Form should be included with the returned product. For more information, please see the reverse side of the invoice that was shipped with the product.

Grafton® DBM, MinerOss®, Mem-Lok®, Laddec® must be returned within ten (10) days of initial invoice. AlloDerm® and AlloDerm® GBR™ may not be returned or exchanged for credit due to storage requirement guidelines.

**Disclaimer of Liability:** BioHorizons products may only be used in conjunction with the associated original components and instruments according to the Instructions for Use (IFU). Use of any non-BioHorizons products in conjunction with BioHorizons products will void any warranty or any other obligation, expressed or implied.

Treatment planning and clinical application of BioHorizons products are the responsibility of each individual clinician. BioHorizons strongly recommends completion of postgraduate dental implant education and adherence to the IFU that accompany each product. BioHorizons is not responsible for incidental or consequential damages or liability relating to use of our products alone or in combination with other products other than replacement or repair under our warranties.

Compu-Guide surgical templates are ordered under the control of a Clinician. The Clinician recognizes responsibility for use. Therefore, regardless of the real or proven damages, the liability to BioHorizons is limited to the price of the product directly related to the reason for the claim.

**Distributed Products:** For information on the manufacturer's warranty of distributed products, please refer to their product packaging. Distributed products are subject to price change without notice.

**Validity:** Upon its release, this literature supersedes all previously published versions.

**Availability:** Not all products shown or described in this literature are available in all countries.

BioHorizons continually strives to improve its products and therefore reserves the right to improve, modify, change specifications or discontinue products at any time. Any images depicted in this literature are not to scale.

# TABLE OF CONTENTS

<b>Icon Legend / Warranty Information</b>	<b>page b</b>
<b>One-piece 3.0 Overview</b>	<b>2</b>
<b>Overdenture Overview</b>	<b>3</b>
<b>Product Ordering Information</b>	
Surgical Kit and Instruments	4
One-piece 3.0 Implants and Accessories	5
Overdenture Implants and Accessories	6-7



<b>One-piece 3.0 Treatment Planning</b>	<b>8</b>
Drilling Sequence / Site Access	9
Osteotomy Initialization / Angulation	10
Depth Drill / Finishing Drill / Bone Tap	11
Implant Pick-up and Placement	12
<b>One-piece 3.0 Prosthetic and Lab Technique</b>	
Abutment Preparation / Impression Making	13
Comfort Cap Provisionalization / Final Prosthesis	14
Alternative Provisionalization Options	15
Optional - Impression for Working Cast with Analog	16



<b>Overdenture Treatment Planning</b>	<b>17</b>
Drilling Sequence / Site Access	18
Position and Angulation / Depth and Width Drills	19
Bone Tapping / Implant Placement	20
<b>Overdenture Prosthetic and Lab Technique</b>	
Initial Stabilization	21
Denture Relief	22
Chairside Attachment Pick-up	23
Positioning and Insert Seating	24
Optional - Impression for Working Cast with Analogs	25

## The 3.0mm Answer for Areas of Limited Space

*BioHorizons One-piece 3.0 is the small-diameter implant of choice for the long-term treatment of missing maxillary laterals and mandibular incisors. It allows treatment of spaces that cannot be handled with larger two-piece implants.*

- **Maximum Strength - Minimum Profile.** Its one-piece, titanium alloy construction provides maximum strength, while its 3.0mm diameter allows placement in areas of limited tooth-to-tooth spacing. The One-piece 3.0 has been shown to be stronger when loaded to failure than other implants less than 4mm in diameter.<sup>2</sup>
- **Minimal Surgery - Maximum Esthetics.** Because One-piece 3.0 implants are placed using a single-stage protocol, the soft tissue experiences less trauma than typical two-stage protocols. It also has a 96.7% success rate when immediately loaded.<sup>3</sup>

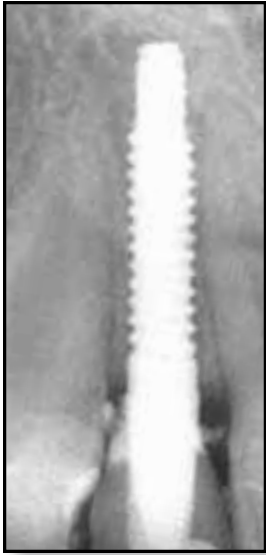

## BioHorizons One-piece 3.0 Specifications

- Material:** Titanium Alloy – Ti-6Al-4V
- Surfaces:** Resorbable Blast Texturing (RBT) or Hydroxylapatite (HA)
- Diameter:** 3.0mm
- Lengths:** 12, 15 and 18mm



*products shown not to scale*

### Bridging the Gap between “Minis” and Two-piece Implants

*BioHorizons Overdenture implant system provides a long-term denture stabilization solution. Its cost and simplicity bring secure dentures within reach of many patients who cannot afford conventional treatment plans requiring bone grafts.*

- **Maximum Strength - Minimum Profile.** Its one-piece, titanium alloy construction provides maximum strength, while its 3.0mm diameter allows placement in narrow ridges. The clinically proven modified-square-thread form and Resorbable Blast Texturing (RBT) surface maximize bone-to-implant contact and osseointegration.
- **Minimal Surgery - Maximum Simplicity.** Overdenture implants are placed using a single-stage protocol, with options for either flapped or flapless surgery. For simplicity, each implant comes packaged with the complete attachment system with options for three levels of retention.



### BioHorizons Overdenture Specifications

- Material:** Titanium Alloy - Ti-6Al-4V
- Surfaces:** Resorbable Blast Texturing (RBT)
- Diameter:** 3.0mm
- Length:** 12, 15 or 18mm
- Collar Height:** 2 or 4mm to address variable tissue thickness
- Includes:** Complete Ball Attachment Set



*products shown not to scale*

Surgical Kit and Components



**160-300**  
**One-piece 3.0 / Overdenture Surgical Kit**  
 Includes all the instruments shown below.

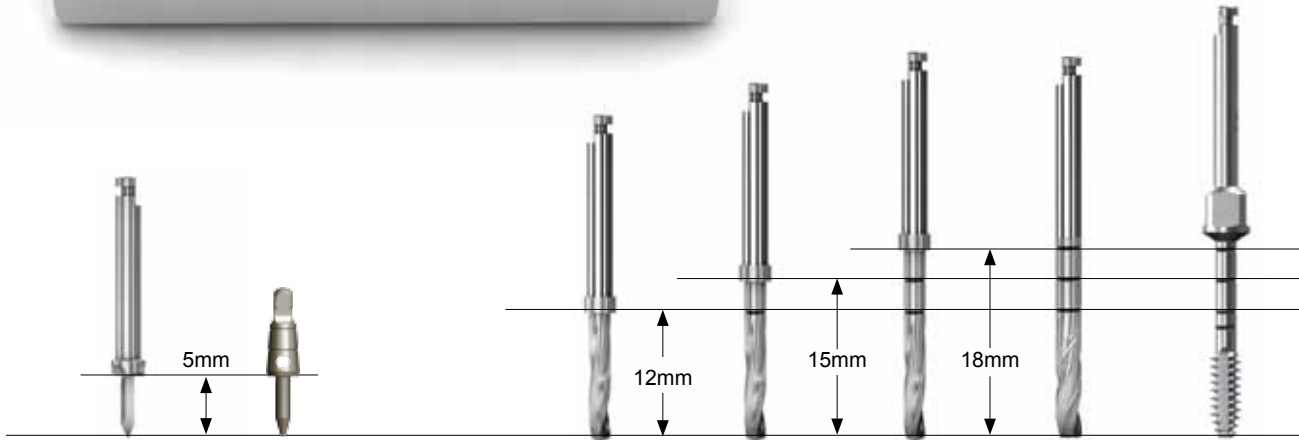

**122-104**  
 Alignment Drill

**144-400**  
 Trial Implant  
 (3 per kit)

**122-52012**  
 Ø2.0 x 12mm  
 Depth Drill

**122-52015**  
 Ø2.0 x 15mm  
 Depth Drill

**122-52018**  
 Ø2.0 x 18mm  
 Depth Drill

**122-525**  
 Ø2.5 Finishing  
 Drill

**122-900**  
 Bone Tap  
 Drill



**122-200**  
 Tissue Punch



**133-000**  
 3.0 Handpiece Adapter\*



**133-000OS**  
 Overdenture  
 Handpiece Adapter\*



**122-100**  
 Drill Extension



**330-200**  
 3.0 Ratchet Adapter\*



**330-200OS**  
 Overdenture  
 Ratchet Adapter\*



**300-400**  
 Hand Wrench\*



**130-000**  
 Ratchet

\*instrument o-rings & c-rings wear out over time. If an instrument is no longer held securely by its associated driver, order a replacement ring through Customer Care.  
 products shown not to scale

# ONE-PIECE 3.0 IMPLANTS AND ACCESSORIES

## One-piece 3.0 Implants

The stated length is measured from the apex to the top of the small flare at the base of the abutment portion of the implant. Resorbable Blast Texturing (RBT) or Hydroxylapatite (HA) surface treatments. Titanium alloy (Ti-6Al-4V).



- OPR3012**    **One-piece Implant 3.0mm x 12mm, RBT**
- OPR3015**    **One-piece Implant 3.0mm x 15mm, RBT**
- OPR3018**    **One-piece Implant 3.0mm x 18mm, RBT**
- OPH3012**    **One-piece Implant 3.0mm x 12mm, HA**
- OPH3015**    **One-piece Implant 3.0mm x 15mm, HA**
- OPH3018**    **One-piece Implant 3.0mm x 18mm, HA**

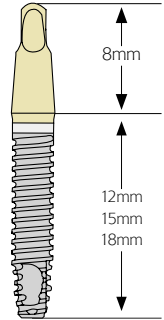

## Accessory Products for One-piece 3.0 Implants



### **MCC**    **One-piece 3.0 Comfort Cap**

Cementable polycarbonate temporary cap for the One-piece 3.0. May be used as is, or have acrylic added to create an esthetic provisional crown. See page 14 for details.



### **292-000**    **One-piece 3.0 Implant Analog**

Used to create a working cast of an unprepared One-piece 3.0 implant. See page 16 for details. Titanium alloy (Ti-6Al-4V)



### **122-107**    **Prepping Bur**

Friction-grip, carbide bur used to modify abutment portion of implant. Sold separately.

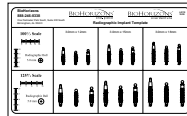

### **L0110**    **Radiographic Implant Template (overlay)**

Designed to aid the clinician in the determination of available bone for implant placement. The clear overlay template shows all sizes of One-piece 3.0 and Overdenture implants in 100% and 125% scale.



### **ATW**    **ITL Precise Adjustable Torque Wrench**

Designed to place both implants and abutments with 9 distinct torque settings (15, 20, 25, 30, 35, 40, 45, 50 and 60 Ncm). A simple twist of the handle locks in precision-engineered torque values and guarantees accuracy and repeatability.



### **ML0103**    **Patient Education – If you have missing teeth...**

This four-fold brochure helps the implant candidate understand the rationale and the advantages of implant therapy compared to traditional treatment methods. The message focuses on the positives of implants and their ability to stop the bone loss associated with edentulism. 50 brochures per package.

# OVERDENTURE IMPLANTS AND ACCESSORIES

## Overdenture Implants

The stated length is measured from the apex to the base of the machined collar. A Ball Attachment Set (ref. MBAS) is provided with each implant at no additional cost. Titanium alloy (Ti-6Al-4V) with Resorbable Blast Texturing (RBT) surface.



- |                |   |
|----------------|---|
| <b>3012OS2</b> | <b>Overdenture Implant 3.0mm x 12mm, 2mm collar</b> |
| <b>3015OS2</b> | <b>Overdenture Implant 3.0mm x 15mm, 2mm collar</b> |
| <b>3018OS2</b> | <b>Overdenture Implant 3.0mm x 18mm, 2mm collar</b> |
| <b>3012OS4</b> | <b>Overdenture Implant 3.0mm x 12mm, 4mm collar</b> |
| <b>3015OS4</b> | <b>Overdenture Implant 3.0mm x 15mm, 4mm collar</b> |
| <b>3018OS4</b> | <b>Overdenture Implant 3.0mm x 18mm, 4mm collar</b> |

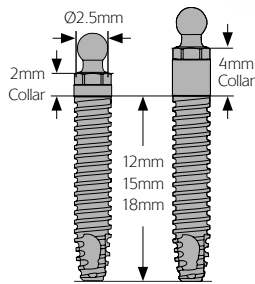

## Ball Attachment Set & Accessories



- MBAS**      **Overdenture Ball Attachment Set**  
 Packaged with each Overdenture implant. Includes: (1) Titanium Housing, (3) Female Nylon Inserts - green (elastic retention), yellow (extra soft retention), black (lab processing) and (1) Protective Disk (ref. BCPD, protects tissue during impression making or denture pick-up)



- BCAHT**      **Attachment Housings - Titanium**  
 For resin pickup or soldering. 2 per package.



- BCIB**      **Black Nylon Insert**  
 Lab processing and chair-side denture pick-up. 2 per package.



- BCIG**      **Green Nylon Insert**  
 Clinical use. 2 per package.  
 Elastic retention.



- BCIY**      **Yellow Nylon Insert**  
 Clinical use. 2 per package.  
 Extra soft retention: 1.4lb / 525g



# OVERDENTURE IMPLANTS AND ACCESSORIES

## Overdenture Accessories

**BCIST** **Insert Seating Tool**  
Used to seat nylon inserts in attachment housings.



**BCR** **Reamer**  
Used to adjust retention of nylon inserts.



**OSDR** **Directional Rings**  
Used for obtaining parallelism.  
Set of 3: 0°, 7°, and 14° rings  
Color-coded, multiple-use titanium.



**BCIP** **Pink Nylon Insert**  
Clinical use. 2 per package.  
Soft retention: 2.3lb / 875g



**BCAA** **Ball Attachment Analog**  
Used for fabrication of model.



**BCIW** **White Nylon Insert**  
Clinical use. 2 per package.  
Standard retention: 3.3lb / 1250g



**MOSM** **Overdenture Patient Education Model**  
Designed to aid the clinician in educating patients on the Overdenture System. Features four Overdenture implants in a clear acrylic mandible and a lower denture with the incorporated attachment housings.

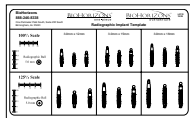

**L0110** **Radiographic Implant Template (overlay)**  
Designed to aid the clinician in determining the available bone for implant placement. The clear overlay template shows all sizes of One-piece 3.0 and Overdenture implants in 100% and 125% scale.



**ML0114** **Patient Education – Denture Stabilization**  
This brochure helps the implant candidate understand the rationale and the advantages of implant therapy compared to traditional treatment methods. 50 brochures per package.



BioHorizons One-piece 3.0 placed in maxillary lateral site using a flapped surgical technique.



Three month follow-up showing excellent papillary fill and tissue health.

*Clinical images courtesy of Dr. Michael Reddy and Dr. Jean O'Neal, University of Alabama at Birmingham*

### Treatment Planning Considerations

One-piece 3.0 implants are specifically indicated for the replacement of maxillary lateral incisors and mandibular central and lateral incisors. They are cleared for immediate non-occlusal provisionalization in single-tooth restorations. Multiple-unit restorations should be splinted together and may, when deemed clinically appropriate, be put into immediate function.

Candidates for One-piece 3.0 implants should have uncompromised oral health, as well as favorable and stable occlusal relationships. Adequate mesial/distal and buccal/lingual bone volume must be present. Implant length (12, 15 or 18mm) should be chosen to make maximum use of available bone height. Bone density must be sufficient to provide initial rigid fixation (final insertion torque between 35-50 Ncm). Implants failing to exhibit adequate fixation must be removed and replaced with a larger diameter implant, or removed and the site grafted in preparation for future implant or conventional crown & bridge therapy.

One-piece 3.0 implants should not be used in cases requiring more than 10 degrees of angulation correction or in cantilevered restorations. Progressive or staged loading and implant-protected occlusal schemes are recommended whenever possible. Because of the high level of osseointegration achieved by One-piece 3.0 implants, they are NOT recommended for use as transitional implants.

The One-piece 3.0 / Overdenture Surgical Kit (ref. 160-300) provides the necessary instruments for proper positioning and osteotomy preparation for One-piece 3.0 implants. BioHorizons strongly recommends the use of the Surgical Kit for the placement of One-piece 3.0 implants. **Placement without the kit voids the implant's Lifetime Warranty.** Please refer to the Instructions for Use for further information on indications and contraindications of One-piece 3.0 implants.

The procedures illustrated and described within this manual reflect idealized patient presentations with adequate bone and soft tissue to accommodate implant placement. No attempt has been made to cover the wide range of actual patient conditions that may adversely affect surgical and prosthetic outcomes. **Clinician judgment as related to any specific case must always supersede any recommendations made in this or any BioHorizons literature.**

## One-piece 3.0 Drill Sequence

The recommended drilling sequence for One-piece 3.0 implants is shown at the right. Clinicians may opt to omit an instrument when deemed appropriate due to variations in bone density or morphology.

Drilling should be done under a constant stream of sterile irrigation, with a drill speed of 850 to 2,500 rpm. A pumping motion should be employed to help prevent overheating the bone. BioHorizons recommends the replacement of drills after 12 to 20 osteotomies.<sup>1</sup>

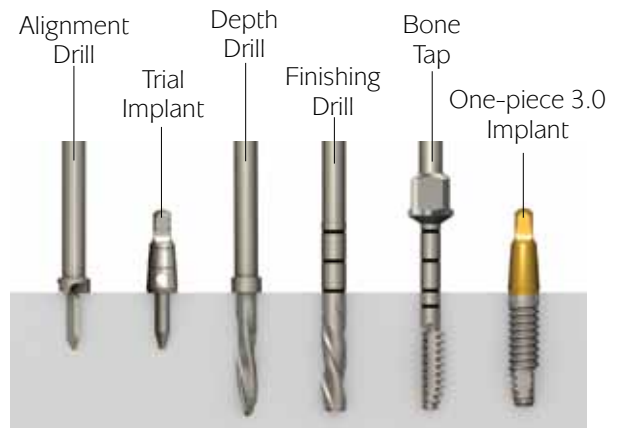

## Site Access

The Tissue Punch may be used to gain access to the site when preoperative diagnosis has shown adequate bone volume is present. A conventional flap should be created if better visualization of the osseous morphology is desired. A safety margin of at least 1mm should be maintained from adjacent roots or any other vital anatomic structure.

A Radiographic Template (overlay) is provided to assist the clinician in the preoperative determination of the space available for implant placement.



Tissue Punch access

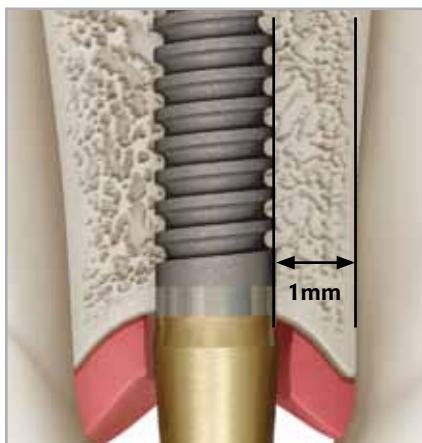

Maintain a safety margin of  $\geq 1$ mm from vital structures



Conventional flap access

*products shown not to scale*

## Osteotomy Initialization

The Alignment Drill is used to initiate the osteotomy to a depth of 5mm. The cutting surface of the drill hub prepares the crestal bone to accept the stop geometry of the Depth Drill and the Trial Implant. The drill has an aggressive cutting geometry to function well in dense cortical bone. It also has the ability to side-cut, allowing clinicians to revise the position or angulation of the osteotomy prior to proceeding to the  $\text{\O}2.0\text{mm}$  Depth Drills.

Care must be taken to ensure the drill does not over-prepare the osteotomy to a greater depth than desired. See page 4 for details regarding drill dimensions.

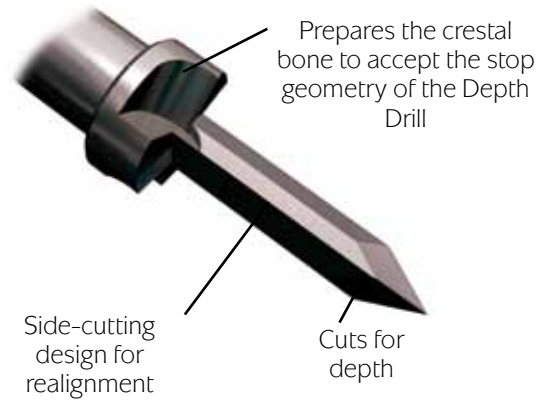

## Verification of Position and Angulation

The Trial Implants replicate the geometry of the implant's abutment portion. They are placed in the initialized osteotomy to verify position and angulation. A radiograph may be taken to evaluate an osteotomy's proximity to adjacent anatomic structures.

Soft tissue thickness can be assessed using the 2mm reference marks on the Trial Implants. The osteotomy's position and angulation may be corrected using the side-cutting ability of the Alignment Drill.

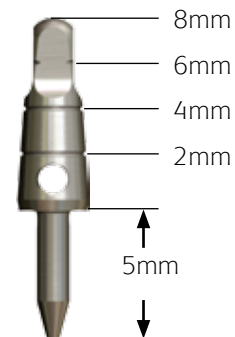

# DEPTH DRILL / FINISHING DRILL / BONE TAP

## Depth Drills

The osteotomy depth is established using one of the three  $\text{\O}2.0\text{mm}$  Depth Drills. Each Depth Drill has a fixed stop corresponding to one of the three implant lengths (either 12, 15 or 18mm). The fixed stop prevents the drill from preparing the osteotomy deeper than desired.

The 15mm and 18mm Depth Drills have additional depth marks for reference.

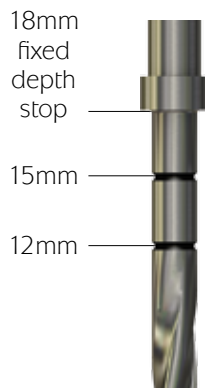

## Finishing Drill

The osteotomy is widened to  $\text{\O}2.5\text{mm}$  using the Finishing Drill. Use of the Finishing Drill may not be necessary in softer (D3-D4) bone. It has depth marks at 12, 15 and 18mm.

The Finishing Drill has a non-end-cutting tip designed to help it stop at the depth determined by the previous Depth Drill. However, because variations in bone density may be encountered within the osteotomy, clinicians must observe the depth marks as the primary determinant of depth.

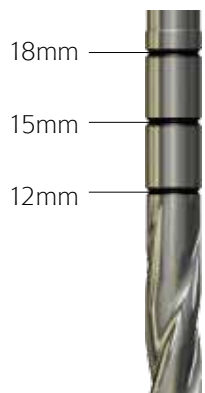

## Bone Tap

The use of the Bone Tap is typically only required in sites where dense cortical bone (D1) is present. It is driven using a low-speed latch-type handpiece. The Bone Tap has depth marks at 12, 15 and 18mm.

Place the tip of the Bone Tap into the osteotomy, apply firm apical pressure and begin rotating at 30 rpm or less in a clockwise direction. When the threads engage the bone, allow the tap to advance without excessive pressure. Remove the Bone Tap by reversing the Handpiece and allowing it to back out of the osteotomy. Do not pull on the Bone Tap to remove it from the site.

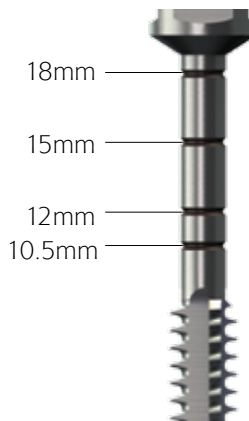

## Implant Pick-up

Hold the sterile vial in an upright fashion and remove the cap by rotating it in a counter-clockwise direction. The implant can then be removed from the vial by engaging the top of the abutment portion with the desired Adapter, either Handpiece or Ratchet.

The Adapters have dimples which provide a visual index for retrieving the implant from the sterile package. Align the dimple with one of the flats on the abutment and push down gently to seat the implant into the adapter (see detail below). Do not touch the implant surface during the transfer.



## Implant Placement

Thread the implant into the osteotomy at 30 rpm or less. The Ratchet Adapter may be used *in lieu* of the Handpiece Adapter when preferred; it will fit either the Hand Wrench or the Ratchet.

Implants are typically seated with the crestal bone level between the top of the surface treatment and the flare of the abutment (1.5mm zone, see detail below). Take care not to overtorque the implant as bone stripping or pressure necrosis may occur.

The peel-and-stick labels on the blister tray should be placed in the patient's chart as a record of the device(s) used.

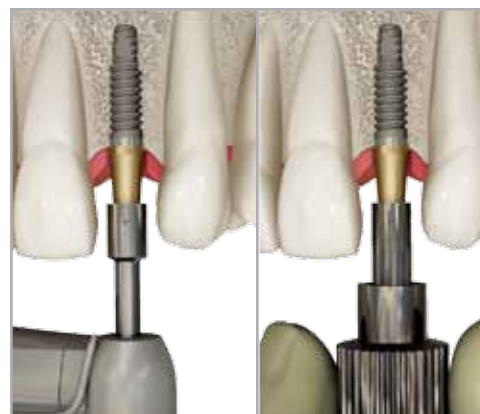

Handpiece  
Adapter

Hand  
Wrench

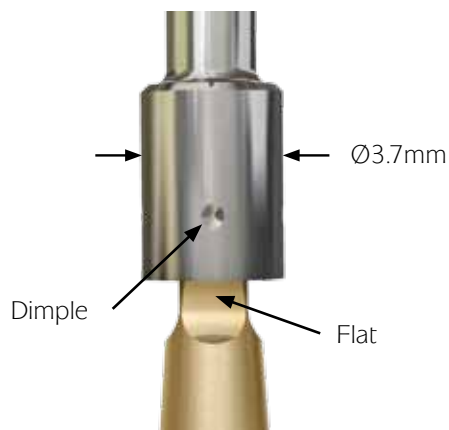

The diameter of the adapters is 3.7mm for clearance in narrow spaces

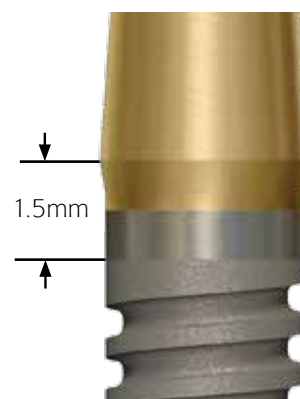

Implants are typically seated with the crestal bone level at or between the top of the surface treatment and the flare of the abutment (1.5mm zone).



## Abutment Preparation

Determine if the abutment portion of the implant requires any modification for height or angulation. A clear thermoform tray created from a diagnostic model can be seated over the placed implant to help make this determination.

If the abutment requires modification, use a high-speed handpiece with a carbide bur. Modification should always be done under a continuous stream of irrigation to prevent overheating.

If the preparation is done immediately following surgery, a rubber dam should be placed over the abutment section to prevent debris from entering the surgical site.

*NOTE: An intraoral scan of the abutment may be made with a handheld infrared camera if a computer-assisted design/ computer-assisted machined (CAD/CAM) restoration is desired. See page 14 for more information.*



## Make Impression

The modified abutment is then treated as a normal crown & bridge case (gingival retraction will be required if a subgingival margin was prepared).

Standard closed-tray technique is used to record a full-arch impression. Syringe a small amount of light body impression material around the abutment to ensure an accurate impression, and seat the loaded impression tray.

Because of the small diameter of the implant abutment, a pin-reinforced stone or epoxy die is recommended. The final crown is then fabricated on the model.

*NOTE: The working cast may be scanned by optical or touch-device methods if a CAD/CAM restoration is desired. See page 14 for more information.*

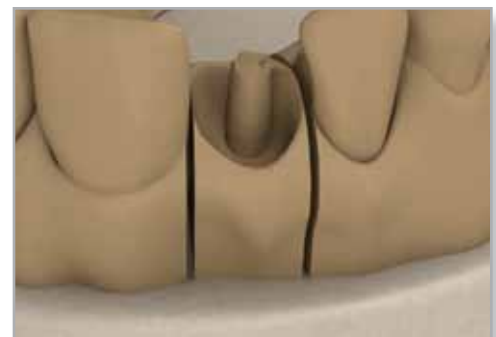

### Comfort Cap Provisionalization

A Comfort Cap (MCC) is available for provisionalization during initial healing and while the final prosthesis is being fabricated. It is made of polycarbonate and should be retained with temporary cement.

Acrylic may be added to the Cap and shaped for better esthetics and to develop an emergence profile. Score the exterior of the Cap to increase surface area for a better mechanical bond.

All single-tooth provisional restorations should be out of functional occlusion. Immediate function may be used when multiple implants are splinted together, if deemed clinically appropriate. Three additional options for provisionalization of One-piece 3.0 implants are outlined on page 15.



### Final Prosthesis Delivery

The final prosthesis is typically delivered after a healing period of 3-6 months, depending on bone density and function. Sanitize the prosthesis and place a small amount of soft-access cement around the inside margin. Seat the prosthesis and remove all excess cement from sulcus area. Take an x-ray for final prosthesis delivery records and release the patient with proper oral hygiene instructions.



### Optional Technique: All-ceramic restorations

*One-piece 3.0 implants may be restored using CAD/CAM technology. The process can be initiated by either an intraoral scan on the placed implant with a small handheld infrared camera or by an optical or physical touch-device of the stone cast at the dental laboratory.*

*Information from the scan will be entered into a computer program where it will be used by the clinician or technician to design a custom prosthesis. The design is then entered into an automated milling machine which mills the prosthesis out of solid ceramic. Following milling, the fit and occlusion of the prosthesis is verified on the in situ abutment or on the model, and then bonded into place.*



## Maryland Bridge (bonded bridge)

*This and the examples below are only some of the available options for immediate provisionalization of One-piece 3.0 implants. Each case should be individually evaluated to determine the method of provisionalization that will offer the best protection during healing.*

A Maryland Bridge may be fabricated and bonded to the adjacent teeth. The lingual aspect of the crown may be relieved to prevent contact with the implant.



## Essix Appliance

A thermoform tray can be made from the diagnostic model. The area of the missing crown can be filled with acrylic, cured and then relieved to avoid contact with the implant. The patient can wear this cosmetic provisional as a short-term solution while another provisional crown is being fabricated.

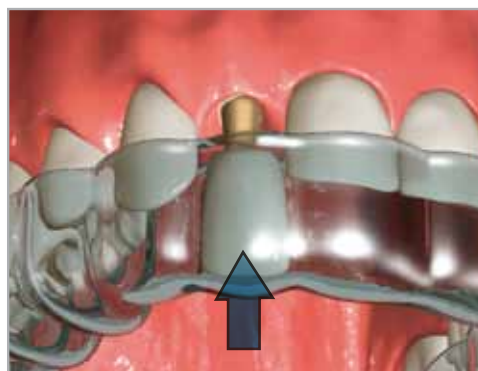

## Provisional Shell Crown

Select the appropriate shell crown. Using the material of choice, fill the crown and seat onto the prepared abutment into the required position. Allow the material to cure per the manufacturer's guidelines. Finish, polish and cement the crown, making sure all excess cement has been removed from the sulcus. Verify the provisional is out of functional occlusion.



## OPTIONAL - IMPRESSION FOR A WORKING CAST WITH ANALOG

## Optional - Impression for a Working Cast with Analog

A One-piece 3.0 Implant Analog is available for fabrication of a working cast, provided **the abutment has not been modified**. If the abutment has been modified in any manner, a standard crown & bridge-type impression must be made (see page 13).

Standard closed-tray technique is used to record a full-arch impression. Syringe a small amount of medium or heavy body impression material around the abutment to ensure an accurate impression, and seat the loaded impression tray.

After the impression material sets, remove the tray and index the Analog into the impression. If desired, soft tissue material may be added to the impression around the implant replica site.

The working cast is poured following conventional lab techniques and the final crown is fabricated according to prescription.



If fabrication of the final crown requires the technician to modify the Analog in the model, a reduction coping must be made to allow the modification to be duplicated intraorally on the implant abutment. Failure to do so will result in the inability to seat the crown in the patient.

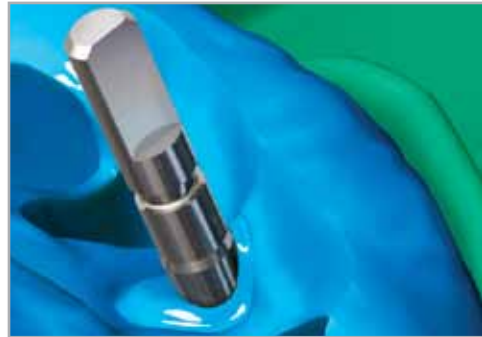



Four BioHorizons Overdenture implants placed using a flapless technique.



The existing denture was relieved and given a soft reline to provide transitional retention during healing.

*Clinical images courtesy of Dr. Michael Reddy and Dr. Michael McCracken, University of Alabama at Birmingham*

## Treatment Planning Considerations

Overdenture implants are designed to stabilize a tissue-supported denture, not to support the prosthesis by themselves. A well-fitting denture with good soft tissue support is essential. Placement of Overdenture implants is contraindicated where more than 30 degrees of divergence is necessary. Overdenture implants are NOT suited for transitional use due to the high degree of osseointegration achieved by the thread design and RBT surface treatment.

A flapped procedure is indicated whenever the amount of available bone or the proximity of critical anatomic landmarks is in question. Clinicians must assess each case to determine the appropriate number of implants necessary for successful treatment. Four implants are typically recommended for dense bone in the mandible. Five or more implants are indicated for softer bone in both the mandible and maxilla. Implant length (12, 15 or 18mm) should be chosen to make maximum use of available bone height. Implant collar height (2mm or 4mm) should be chosen so the RBT portion of the implant is in bone and the ball-top is sitting above the soft tissue.

Overdenture implants must be carefully evaluated for stability before selecting the initial retention level of the denture and/or attachments. Less retention, rather than more retention, is recommended for initial loading. Relief of the denture to avoid contact with the implants (with or without a soft liner material) *in lieu* of the attachments is recommended during the initial healing phase. It is recommended the Attachment Housings be processed into the denture only after rigid fixation or osseointegration of the implants has occurred.

The One-piece 3.0 / Overdenture Surgical Kit (ref. 160-300) provides the necessary instruments for the ideal positioning and osteotomy preparation for Overdenture implants. BioHorizons strongly recommends the use of the Surgical Kit for the placement of Overdenture implants. **Placement without the kit voids the implant's Lifetime Warranty.** Please refer to the Instructions for Use for further information on indications and contraindications of BioHorizons Overdenture implants.

The procedures illustrated and described within this manual reflect idealized patient presentations with adequate bone and soft tissue to accommodate implant placement. No attempt has been made to cover the wide range of actual patient conditions that may adversely affect surgical and prosthetic outcomes. **Clinician judgment as related to any specific case must always supersede any recommendations made in this or any BioHorizons literature.**

### Overdenture Drill Sequence

The recommended drilling sequence for the Overdenture Implant System is shown at the right. Clinicians may opt to omit an instrument when deemed appropriate due to variations in bone density or morphology.

Drilling should be done under a constant stream of sterile irrigation, with a drill speed of 850 to 2,500 rpm. A pumping motion should be employed to help prevent overheating the bone. BioHorizons recommends the replacement of drills after 12 to 20 osteotomies.<sup>1</sup>

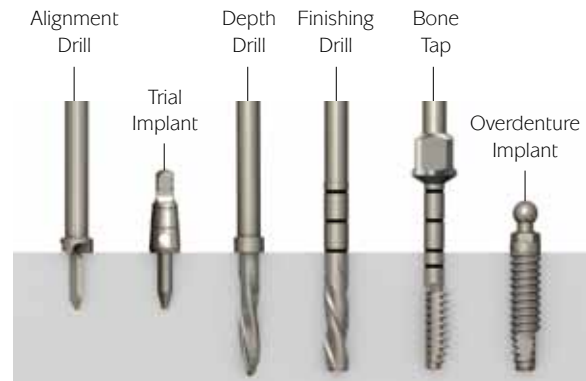

### Soft Tissue Access

The Tissue Punch may be used to gain access to the site. A conventional flap may be created if visualization of the osseous morphology and anatomic landmarks is required. Maintain a safety margin of at least 1 mm from all vital anatomic structures.

A Radiographic Template (overlay) is provided to assist clinicians in the preoperative determination of available bone for implant placement.



### Osteotomy Initialization

The Alignment Drill is used to initiate the osteotomy to a depth of 5mm. The cutting surface of the drill hub prepares the crestal bone to accept the stop geometry of the Depth Drill and the Trial Implant. The Alignment Drill has an aggressive cutting geometry to function well in dense cortical bone. Care must be taken to ensure the drill does not over-prepare the osteotomy to a greater depth than desired. See page 4 for details on drill dimensions.

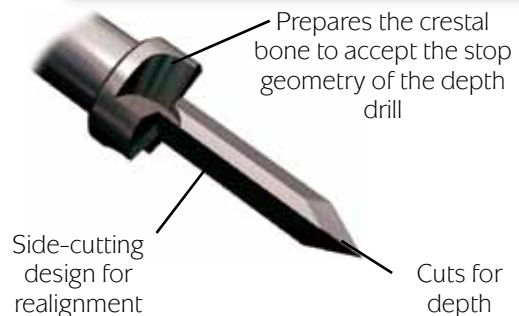
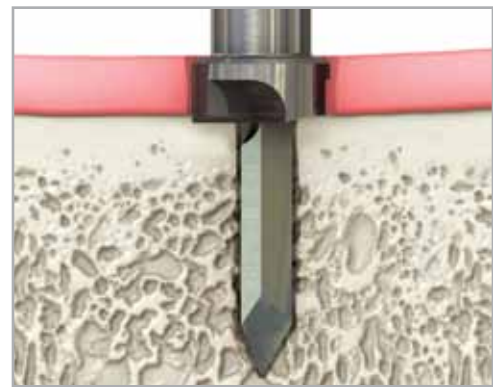

Trial Implants may be placed in the initialized osteotomies to verify their position and angulation. A radiograph may be taken to evaluate the osteotomy's proximity to adjacent anatomic structures. Soft tissue thickness can be assessed using the 2mm reference marks as shown below. The osteotomy's position and angulation may be corrected using the side-cutting ability of the Alignment Drill.

Use the Trial Implants to mirror position and angulation for consecutive implant sites. The minimum recommended center-to-center spacing for Overdenture implants is 6mm. Implants must be placed in a relatively parallel fashion (15 degrees per implant; up to 30 degrees total relative divergence between two implants).

Position and Angulation Verification

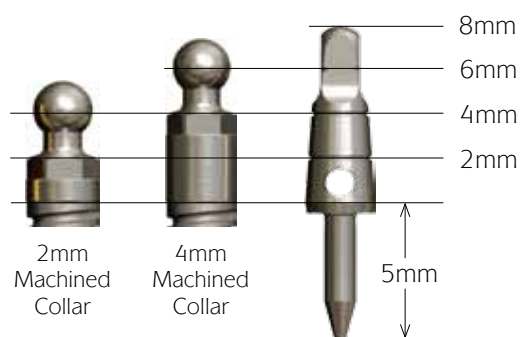
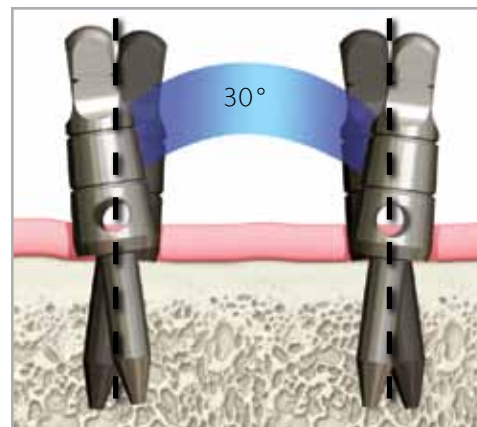

The osteotomy depth is established using one of the three Ø2.0mm Depth Drills. Each Depth Drill has a fixed stop corresponding to one of the three implant lengths (either 12, 15 or 18mm). The fixed stop prevents the drill from preparing the osteotomy deeper than desired.

The 15mm and 18mm Depth Drills have additional depth marks for reference.

Depth Drills

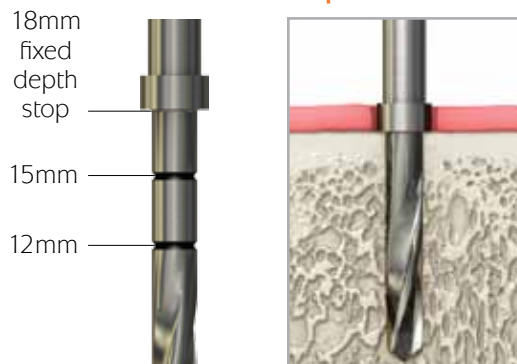

The osteotomy is widened to Ø2.5mm using the Finishing Drill. Use of the Finishing Drill may not be necessary in softer (D3-D4) bone. It has depth marks at 12, 15 and 18 millimeters.

The Finishing Drill has a non-end-cutting tip designed to help it stop at the depth determined by the previous Depth Drill. However, because variations in bone density may be encountered within the osteotomy, clinicians must observe the depth marks as the primary determinant of depth.

Finishing Drill

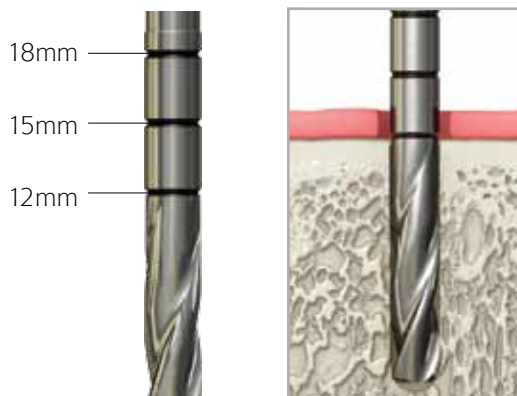

products shown not to scale



## Bone Tap

The use of the Bone Tap is typically only required in sites where dense cortical bone (D1) is present. It is driven using a low-speed latch-type handpiece. The Bone Tap has depth marks at 12, 15 and 18mm.

Place the tip of the Bone Tap into the osteotomy, apply firm apical pressure and begin rotating at 30 rpm or less in a clockwise direction. When the threads engage the bone, allow the tap to advance without excessive pressure. Remove the Bone Tap by reversing the Handpiece and allowing it to back out of the osteotomy. Do not pull on the Bone Tap to remove it from the site.

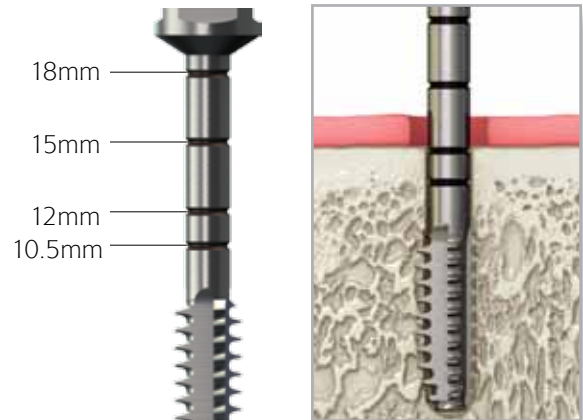

## Implant Pick-up

Implant collar height (2mm or 4mm) should be chosen so the RBT portion of the implant is in bone and the ball-top is sitting above the soft tissue. Hold the sterile vial in an upright fashion and remove the cap by rotating it in a counter-clockwise direction.

Engage the hexagon on the implant collar with the desired Adapter, either Handpiece or Ratchet. The Adapters have dimples to provide a visual index aligning with the hexagon. Align the dimple with one of the hex flats and push down gently to seat the implant into the adapter. Do not touch the implant surface during the transfer.

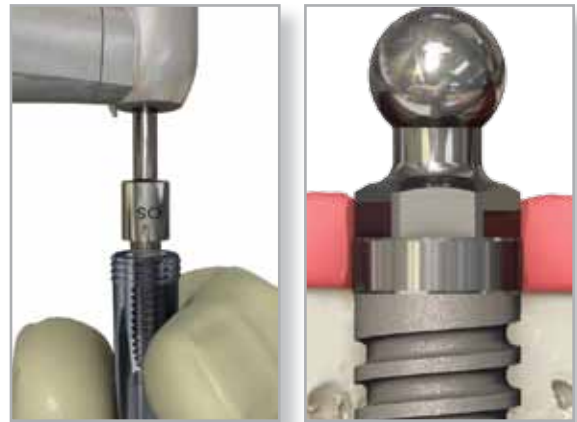

## Implant Placement

Thread the implant into the osteotomy at 30 rpm or less. The Ratchet Adapter may be used *in lieu* of the Handpiece Adapter when preferred; it will fit either the Hand Wrench or the Ratchet.

Overdenture implants are typically placed with the ball portion sitting completely above the soft tissue (as shown above). Take care not to overtorque the implant as bone stripping or pressure necrosis may occur.

The peel-and-stick labels on the blister tray should be placed in the patient's chart as a record of the device(s) used.

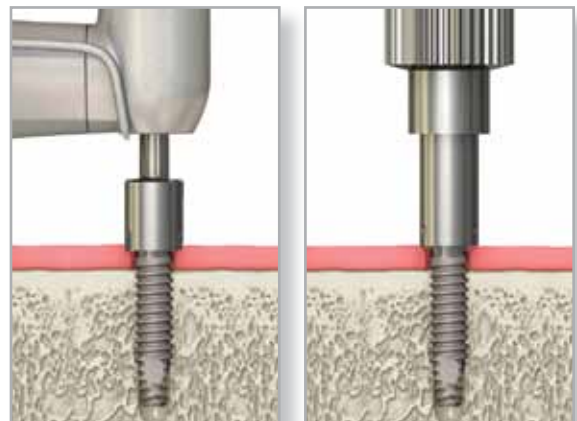

## Initial Stabilization - Day of Placement

It is recommended Overdenture implants be given adequate time to osseointegrate prior to full loading. Initial denture stability can be obtained through the soft lining of the transitional prosthesis (often the existing denture). Relieve the denture to avoid contact with the implants and line with soft reline material during the initial healing phase. It is recommended the Ball Attachment Housings be processed into the denture only after osseointegration has occurred.

Place a transferable mark on top of each ball-top and seat the denture in the patient's mouth to determine where the denture needs to be relieved. Create a trough in the denture to allow complete soft tissue support with no contact between the denture and the implants.

**Flapless Surgery** - A soft reline material may be placed in the trough described above to provide a transitional degree of retention prior to use of the Ball Attachments.

**Flapped Surgery** - A tissue conditioner should be used *in lieu* of soft reline material as it is less likely to irritate the sutured flap margins.

Place the Protective Disks or rubber dam material over the ball-tops, seat the denture and instruct the patient to bite in light centric occlusion until the soft liner or tissue conditioner cures. After the material has cured, remove the denture and fill any voids.

Patient recall should be scheduled with frequency to ensure the soft liner is replaced prior to losing function.



### Relieve Denture to Accomodate Housings

When the existing denture is to be used for a chair-side pick-up of the Attachment Housings, it must be relieved to sit passively over the seated Housing assemblies. Mark the denture to note the position of the ball-tops as captured in the liner material. Remove the liner material from the denture.

Insert Black Positioning Inserts (BCIB) into the Attachment Housings (BCAHT) with the Insert Seating Tool (BCIST) as shown on page 24, and seat on the implant ball-tops.

Try in the denture over the seated Insert / Housing assemblies to determine if further relief is necessary for adequate clearance. 1.5mm to 2.0mm of clearance is suggested around and above each Housing for maximum retention in the denture base.

Holes should be made in the lingual surface of the denture to allow clear visual verification of housing / denture clearance, and permit excess acrylic to escape during the pick-up procedure.

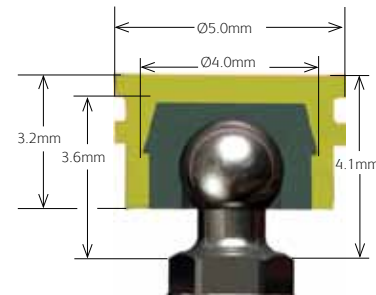
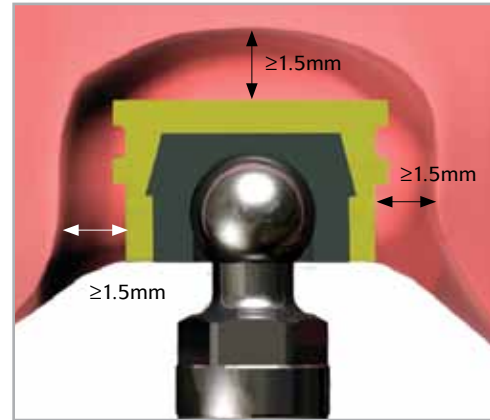

### Chairside Pick-up without Directional Rings

Place Rubber Dam material or the clear Protective Disk over each ball-top. Seat the Insert / Housing assemblies onto the implant ball-tops and rotate the housings to create a parallel path of draw. Block out any undercuts with wax or other appropriate material.

 **The Black Positioning Inserts must be used for chair-side pick-up procedures.** The Yellow and Green Clinical Inserts may provide too much retention and cause the denture to become locked on to the implant ball-tops.

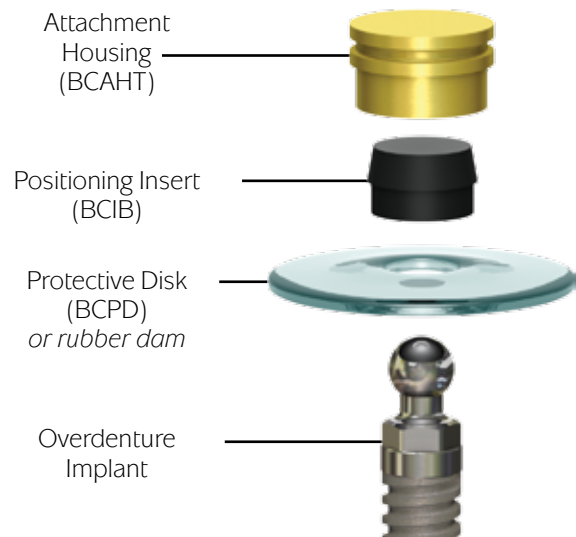



Optional - Chairside Pick-up with Directional Rings

Directional Rings (purchased separately, page 7) are placed to establish and maintain the Attachment Housings in parallel position during a chairside pick-up, or pick-up in the laboratory. The set contains rings of 7° and 14°, as well as a flat ring (0°) for use with relatively parallel implants.

A rubber dam may be used to protect the tissue if desired. Punch 3mm holes in the rubber dam material to accommodate each implant. This ensures the dam seats completely over the hex beneath the ball-top of the implants. The rubber dam should be placed prior to the seating of the Directional Rings and the Insert/Housing assemblies.

Seat the Directional Rings and the Insert / Housing assemblies onto the implant ball-tops. Rotate the Directional Rings to create a parallel path of draw. The Directional Rings serve a secondary function by blocking out potential undercuts, reducing the need to block out the area.

 **The Black Positioning Inserts must be used for chairside pick-up procedures.** The Yellow and Green Clinical Inserts may provide too much retention and cause the denture to become locked on to the implant ball-tops.

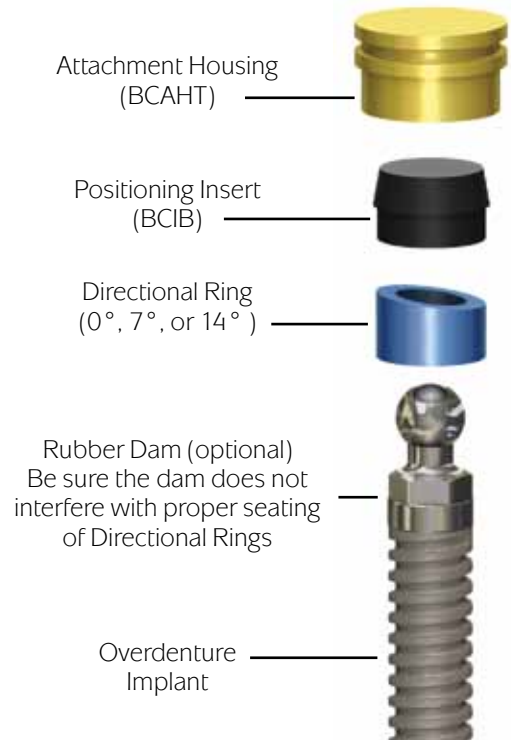

Pick-up of the Housing Assemblies

Place a small amount of acrylic on the top of the Attachment Housings. Fill the relieved area of the denture base with acrylic and place the denture over the housings. Instruct the patient to bite in light centric occlusion. Remove the denture after the acrylic sets and fill in any voids around the housings and polish the denture base as required.

If desired, the Black Positioning Inserts may be left in the denture for a period of time as a transitional step between the soft reline and full retention of the Clinical Inserts. They provide limited retention, but do create a positive vertical stop and increase lateral stability.

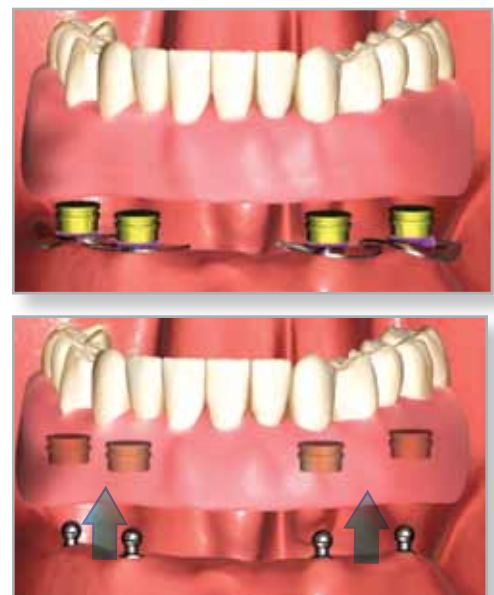

products shown not to scale

### Removal of Black Positioning Inserts

After the pick-up of the housing assemblies has been accomplished, remove the Positioning Inserts from the Attachment Housings with a spooned instrument and proceed with the insertion of the appropriate Clinical Insert and retention adjustment procedure.



### Insert Seating





Clinical Inserts are available with four different retention levels. Overdenture implants are packaged with the two that offer the least retention (green and yellow).

Using the Insert Seating Tool (BCIST), seat the desired Clinical Insert into **ONE** Attachment Housing and try-in the denture. If retention is too great, adjust the retention with the Reamer (BCR) by inserting the tool in the insert and turning clockwise to reduce the retention. When appropriate retention is achieved, continue the same process with the next Insert / Housing.



The duration of Clinical Inserts in the mouth varies from prosthesis to prosthesis, depending on: number and arrangement of attachments / implants, prosthesis balance and other factors. It is recommended to replace the caps every 6-12 months. Patients should be instructed to contact the office immediately if they feel their retention becomes compromised between recalls.

#### Clinical Inserts

Relative Retention			
←—————→			
			
Elastic	Extra Soft	Soft	Standard
Included with Implant		Purchased Separately	



Inserts must be replaced before they wear to the point that allows the Overdenture implant's ball-top to come in contact with the titanium Attachment Housing. Metal-to-metal contact will cause wear to the ball-top, diminishing its retentive ability.

## OPTIONAL - IMPRESSION FOR WORKING CAST WITH ANALOGS

Block out sutures, if present. Place the clear Protective Disk over each implant's ball-top.

Place a Black Nylon Insert / Attachment Housing assembly on each ball-top and arrange in a path of parallel draw. Directional Rings may be used to help align the assemblies. Block out any undercuts with a material of choice.

Use a medium or heavy-bodied impression material to make a closed-tray, full-arch impression that picks up the Insert / Housing assemblies. Syringe a small amount of impression material around each assembly to ensure a good pick-up. Record opposing dentition if necessary.

### Pick-up Housing Assemblies

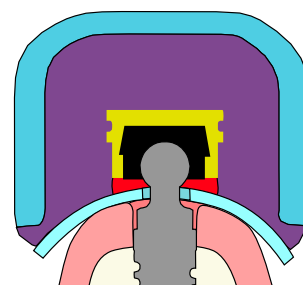
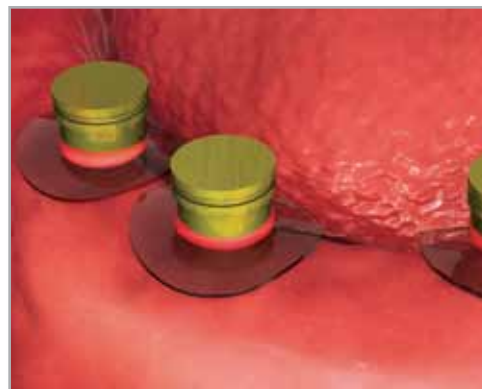

### Insert Analogs

After removing the impression, verify an accurate pick-up was made. Insert the appropriate number of Ball Attachment Analogs (purchased separately, page 7) into the Insert / Housing assembly contained in the impression. Be certain the Analogs are fully seated before pouring the stone.



### Pour the Model / Pick-up the Housings

After pouring the working cast, the Insert / Housing assemblies are retrieved from the impression. The Inserts / Housings can then be incorporated into a baseplate to create a stabilized wax occlusal rim following standard laboratory procedures.



*products shown not to scale*

## Direct Offices

**BioHorizons USA**  
888-246-8338 or  
205-967-7880

**BioHorizons Canada**  
866-468-8338

**BioHorizons Spain**  
+34 91 713 10 84

**BioHorizons UK**  
+44 (0)1344 752560

**BioHorizons Germany**  
+49 7661-909989-0

**BioHorizons Australia**  
+61 2 8399 1520

**BioHorizons Chile**  
+56 2 361 9519

## Distributors

For contact information in our other 70 markets, visit [www.biohorizons.com](http://www.biohorizons.com)

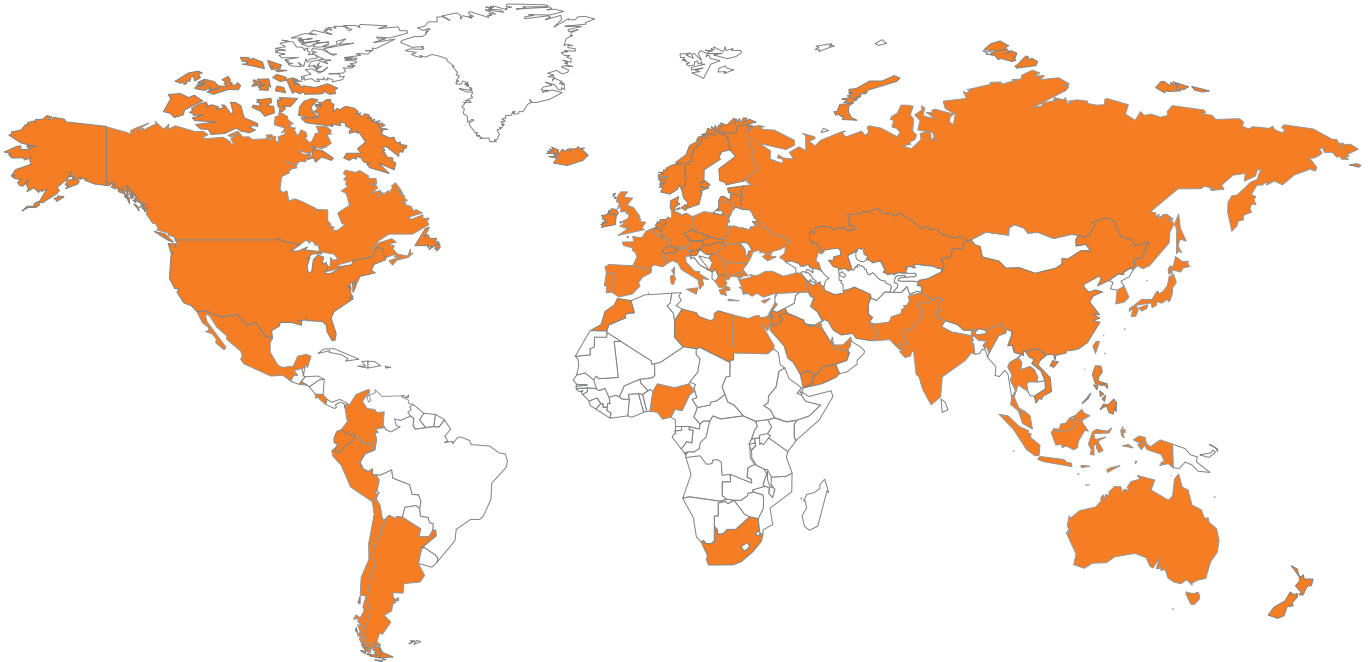

1. Heat production by 3 implant drill systems after repeated drilling and sterilization.  
Chacon G, Bower D, Larsen P, McGlumphy E, Beck F. *J Oral Maxillofac Surg.* 2006 Feb;64(2):265-9
2. The Impact of Loads on 2\_3-Standard Diameter, Small Diameter and Mini Implants: A Comparative Laboratory Study.  
Allum SR, Tomlinson RA, Joshi R. *Clin. Oral Impl. Res.* 2008 May;19(6):553-559.
3. Initial Clinical Efficacy of 3-mm Implants Immediately Placed into Function in Conditions of Limited Spacing.  
Reddy MS, O'Neal SJ, Haigh S, Aponte-Wesson R, Geurs NC. *Int J Oral Maxillofac Implants.* 2008 Mar-Apr;23(2):281-288.

BioHorizons®, Laser-Lok®, MinerOss®, Autotac® and Mem-Lok® are registered trademarks of BioHorizons, Inc.

Grafton® DBM and LADDEC® are registered trademarks of Osteotech, Inc. AlloDerm®, AlloDerm® GBR™ and LifeCell™ are registered trademarks of LifeCell Corporation.

Spiralock® is a registered trademark of Spiralock Corporation. Locator is a registered trademark of Zest Anchors, Inc.

Delrin® is a registered trademark of E.I. du Pont de Nemours and Company. Pomalux® is a registered trademark of Westlake Plastics Co.

Mem-Lok® is manufactured by Collagen Matrix, Inc.

Not all products shown or described in this literature are available in all countries. As applicable, BioHorizons products are cleared for sale in the European Union under the EU Medical Device Directive 93/42/EEC and the tissues and cells Directive 2004/23/EC. We are proud to be registered to ISO 13485:2003, the international quality management system standard for medical devices, which supports and maintains our product licences with Health Canada and in other markets around the globe.

Original language is English. © 2010 BioHorizons, Inc. All Rights Reserved.

shop online at  
**www.biohorizons.com**



ML0109

REV D APR 2010